

# LINDSEY ADELMAN STUDIO

55 Great Jones Street  
New York NY 10012  
212 473 2501

## YOU MAKE IT — SCONCE LIGHT PARTS DIAGRAM

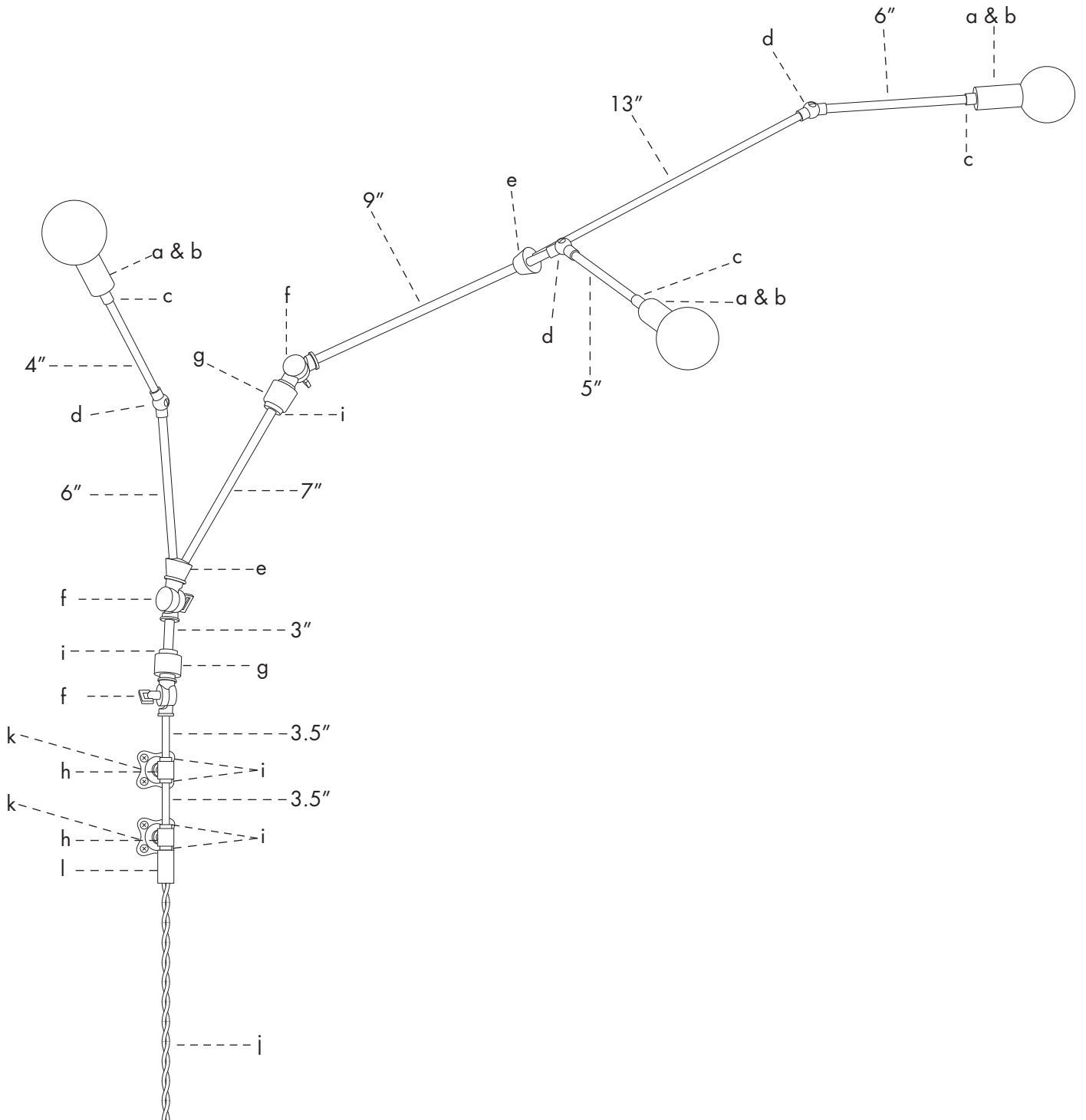

# LINDSEY ADELMAN STUDIO

55 Great Jones Street  
New York NY 10012  
212 473 2501

YOU MAKE IT — SCONCE LIGHT  
PARTS LIST

## From Grand Brass ([www.grandbrass.com](http://www.grandbrass.com)):

- a. 3 candelabra sockets. Item SO20025-IC.
- b. 3 candelabra socket cups. Item CU577BR.
- c. 3 couplings. Item NE449NP.
- d. 3 friction swivels. Item SV140.
- e. 2 cluster bodies. Item BOT2.
- f. 3 large swivels with teeth. Item SV100.
- g. 1 cluster body with no side holes. Item BOSOX8.
- h. 2 straight back tee. Item AB470
- i. 6 bead nuts. Item NU430.
- j. 12 feet cloth covered wire. Item WITWISTGREY.
- k. 2 cast iron flanges. Item FLCROW
- l. 1 1.5" coupling. Item NE 475

### arms:

- 1 - 3" arm. Item PIBP03
- 2 - 3.5" arm. Item PIBP03.5
- 1 - 4" arm. Item PIBP04
- 2 - 6" arm. Item PIBP06
- 1 - 7" arms. Item PIBP07
- 1 - 13" arm. Item PIBP13

### (not shown, various other parts):

- 1 plug. Item PL183W
- 6 nipples, 1/2" long. Item NI0-1/2x1/8.
- 2 blue wire nuts. Item WINUTB.
- 2 grey wire nuts. Item WINUTG.
- Electrical tape. Item TAE60.

## From McMaster-Carr ([www.mcmaster.com](http://www.mcmaster.com)):

- 25 feet white wire. Item 7587K954.
- 25 feet black wire. Item 7587K951.
- Heat shrink tubing. Item 7864K22.

## From House of Antique Hardware ([www.houseofantiquehardware.com](http://www.houseofantiquehardware.com)):

- 4 Small round carbon filament candelabra base bulbs. Item R-010KC-CNDL-RND.

## Tools needed:

- Wire strippers
- Needlenosed pliers
- Flat head screwdriver
- Lighter or hairdryer for heat shrink tubing

# LINDSEY ADELMAN STUDIO

55 Great Jones Street  
New York NY 10012  
212 473 2501

## YOU MAKE IT — SCONCE LIGHT WIRING DIAGRAM

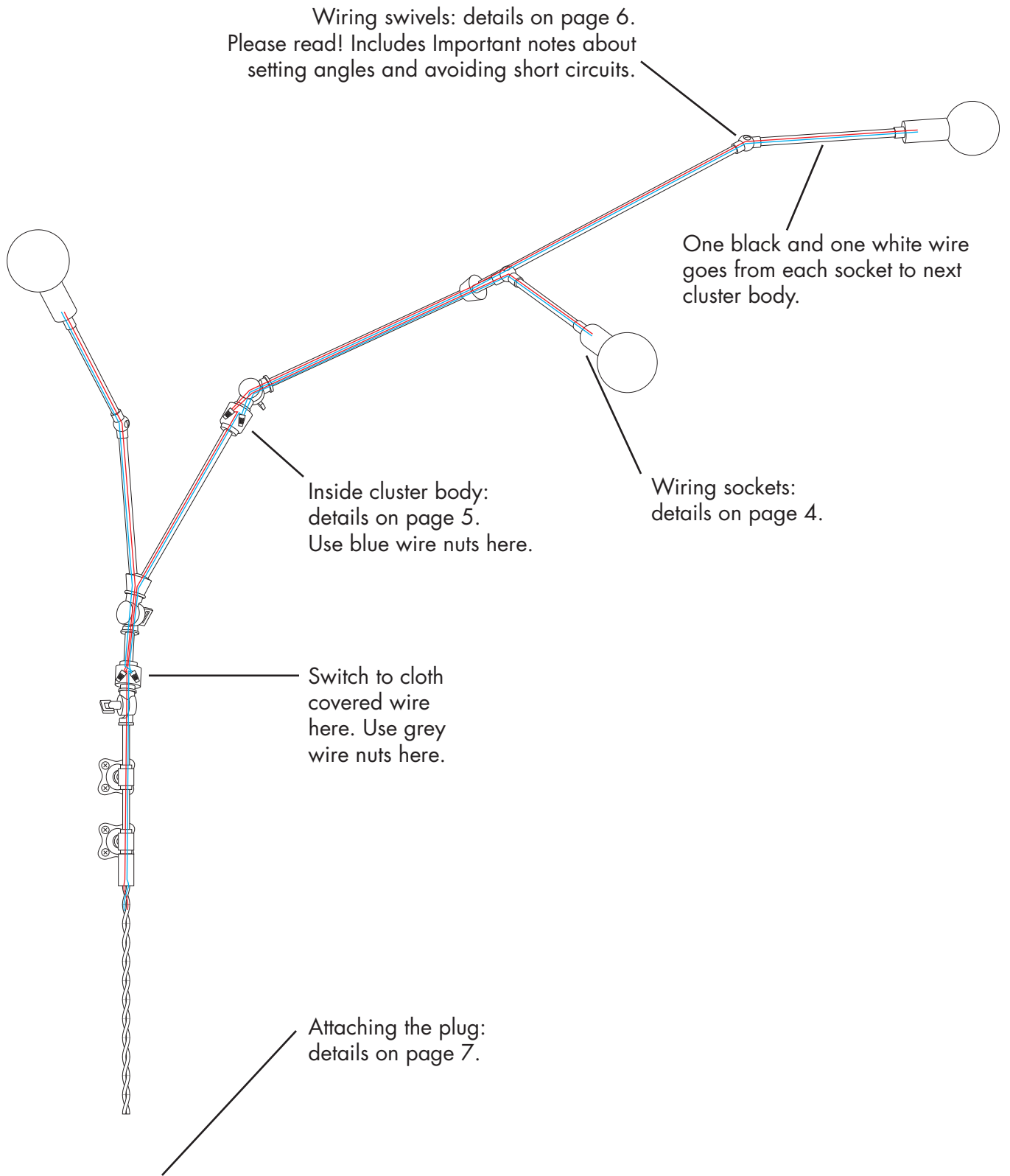

# LINDSEY ADELMAN STUDIO

55 Great Jones Street  
New York NY 10012  
212 473 2501

YOU MAKE IT — SCONCE LIGHT  
WIRING SOCKETS

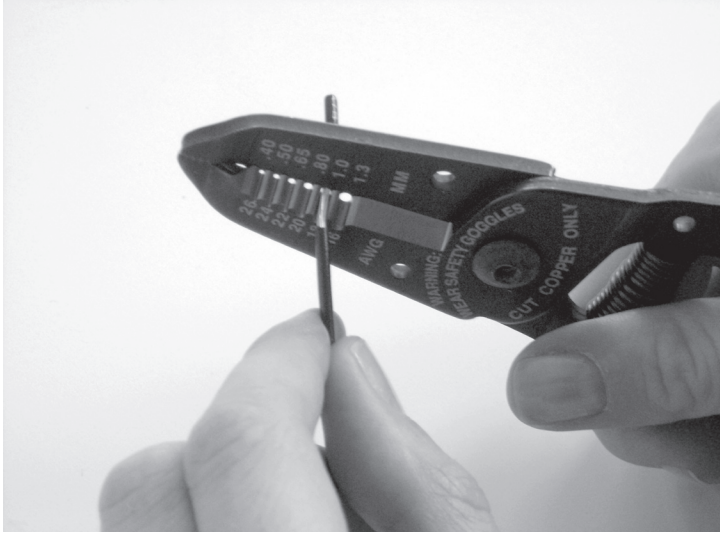

Strip wire and twist the ends.

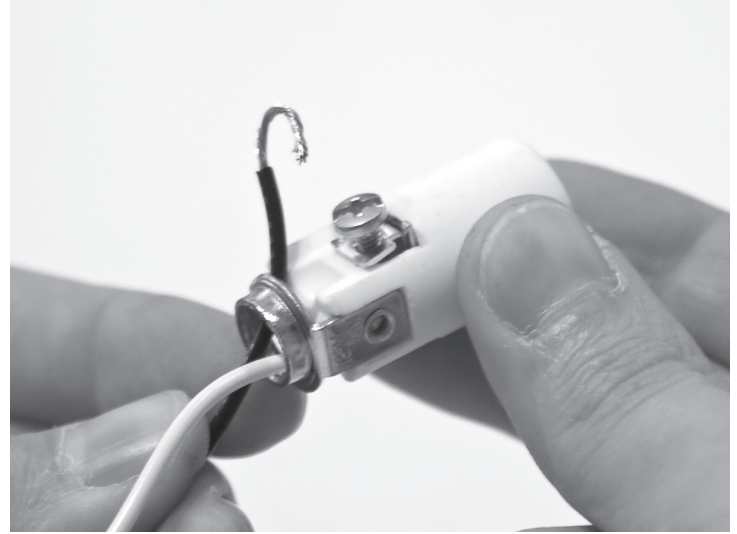

Hook black wire around GOLD screw.



Tighten screw.



Do the same for the white wire and SILVER screw.

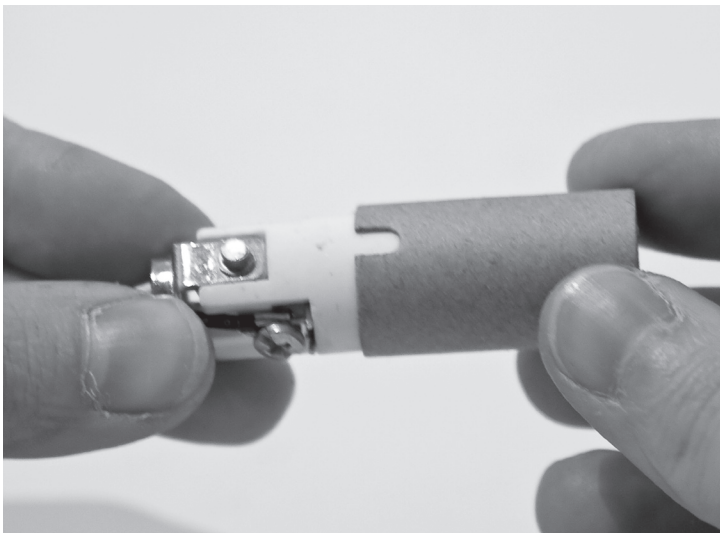

— Slide cardboard sleeve back on.

# LINDSEY ADELMAN STUDIO

55 Great Jones Street  
New York NY 10012  
212 473 2501

## YOU MAKE IT — SCONCE LIGHT INSIDE THE CLUSTER BODY

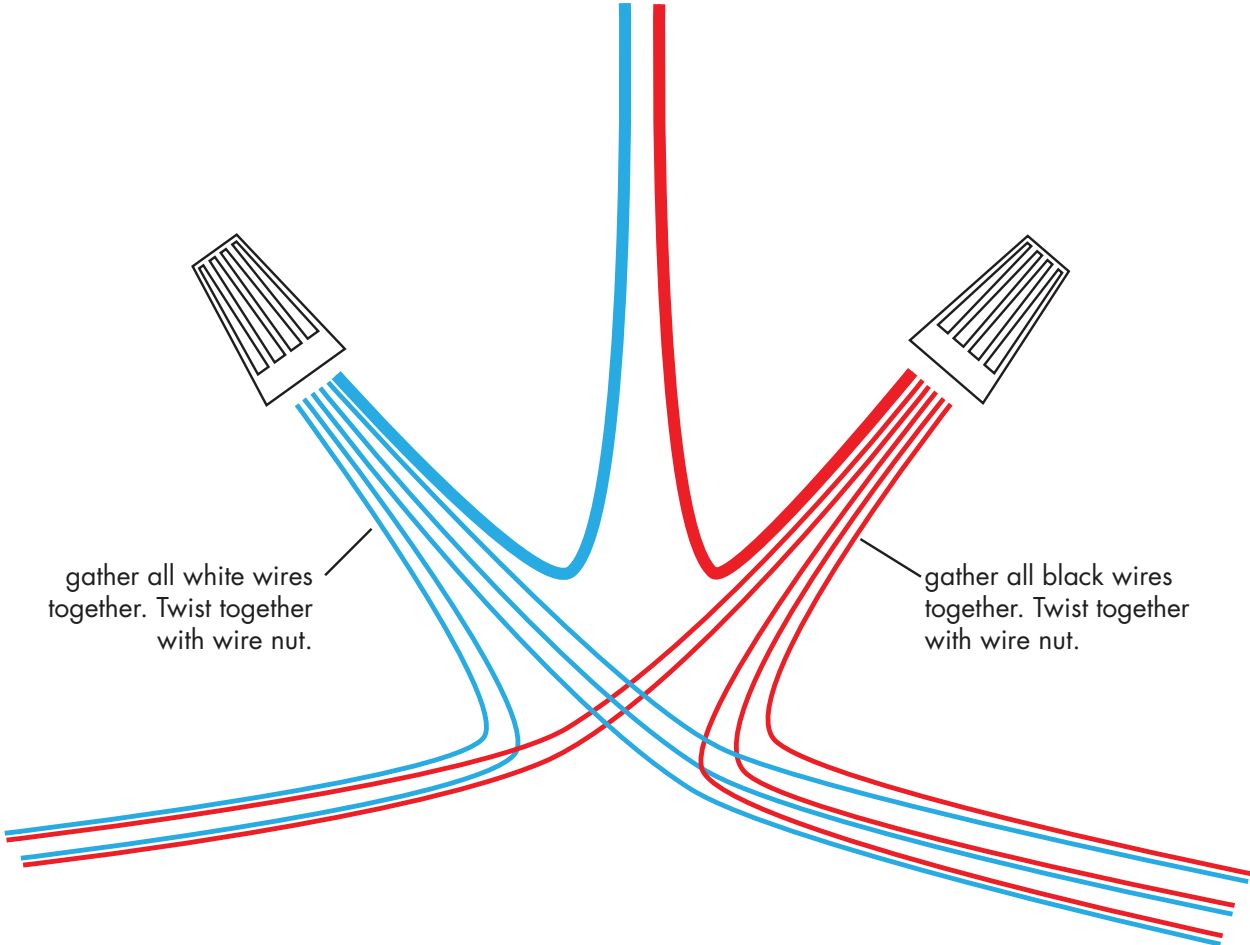



# LINDSEY ADELMAN STUDIO

55 Great Jones Street  
New York NY 10012  
212 473 2501

## YOU MAKE IT — SCONCE LIGHT WIRING SWIVELS



Slip heat shrink over wires. Shrink a little bit nearest the swivel, using a hair dryer or lighter. **BE CAREFUL NOT TO BURN THE WIRES** – move the lighter quickly and stop as soon as tubing has shrunk.

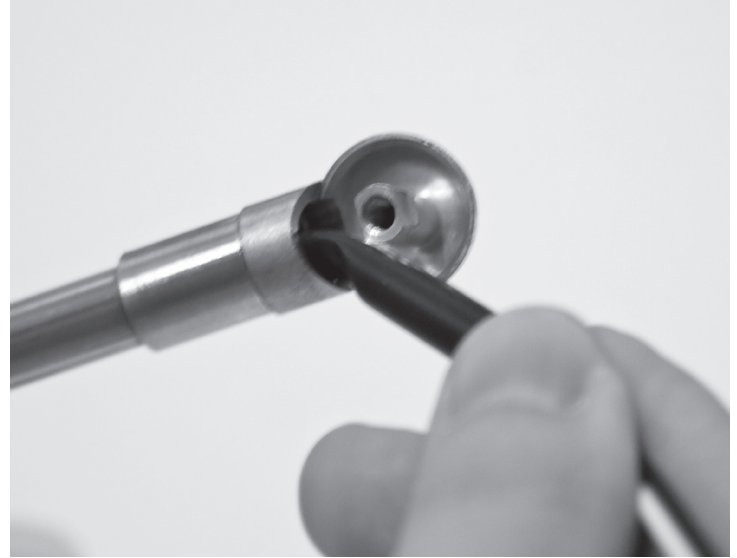

Slip the tubing down toward the swivel, so that the little shrunken bit goes inside the swivel.

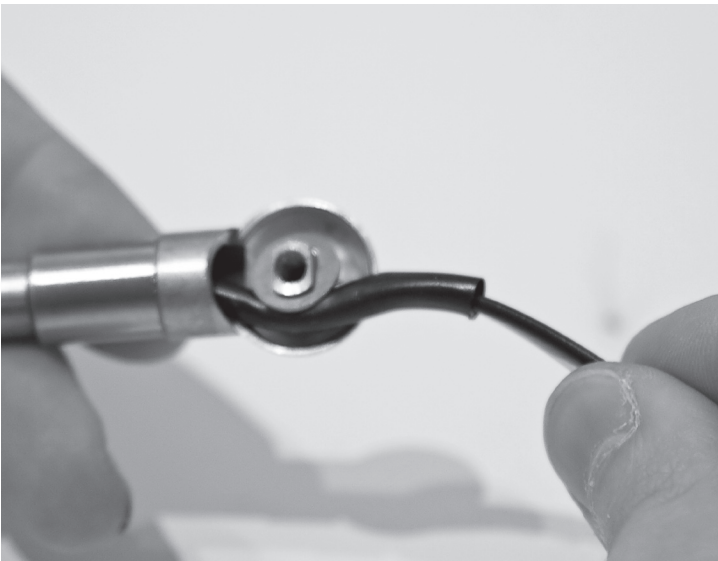

Bend wires and push them into the cavity of the swivel. Place washer over wires. It is best to set your angle now and not change – too much swiveling back and forth can cut the wires and cause a short circuit.



Place the second half of the swivel on and tighten with the screw, making sure not to trap any wires between the two halves.

# LINDSEY ADELMAN STUDIO

55 Great Jones Street  
New York NY 10012  
212 473 2501

## YOU MAKE IT — SCONCE LIGHT ATTACHING THE PLUG

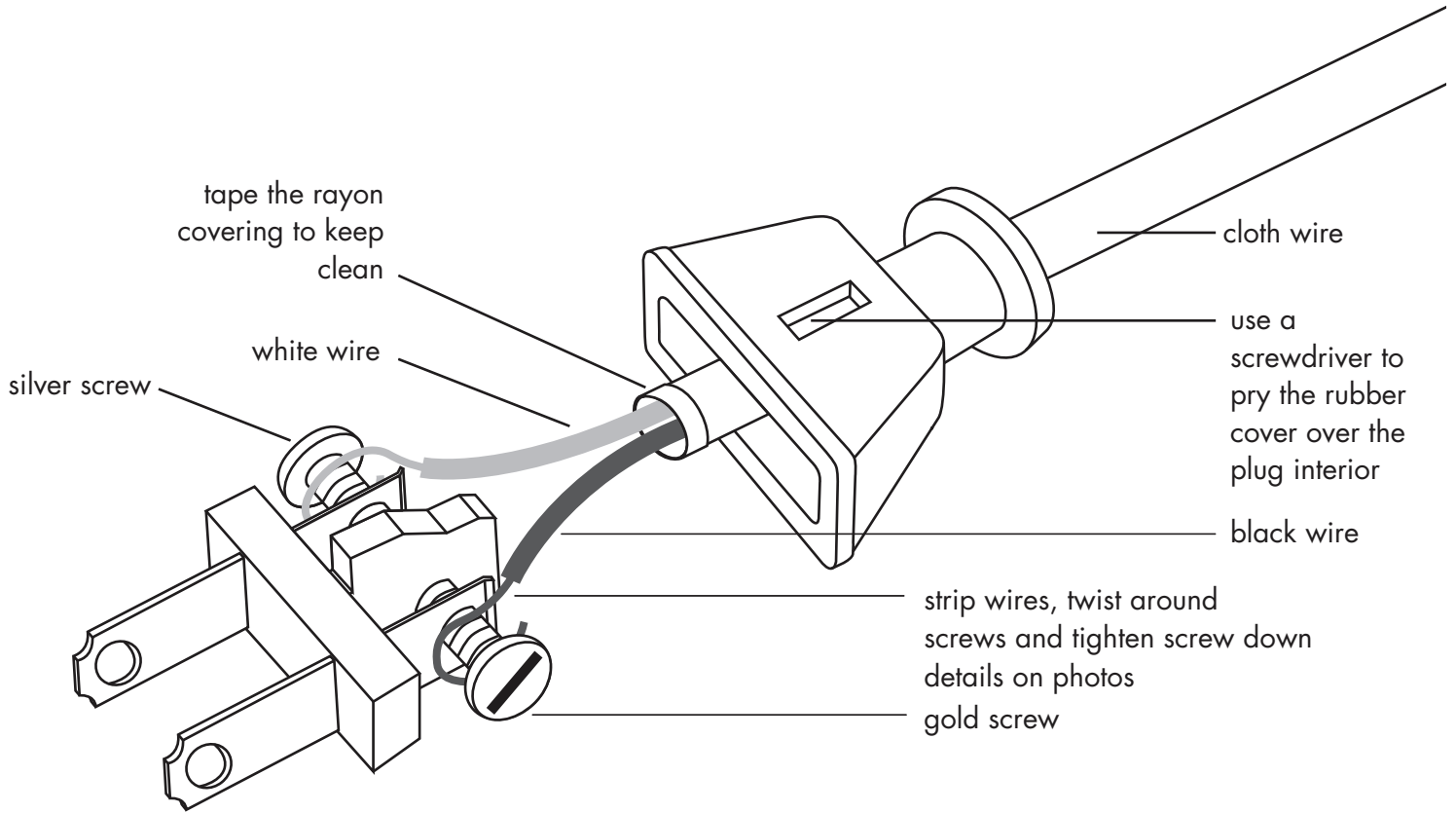

Lindsey Adelman Studio provides this information solely as a guide, and cannot be held liable for any consequences whatsoever. DIY can go wrong, and it therefore must be stressed that nothing should be attempted without applying common sense, and only if you are confident in your ability to carry out the job with safety (both your own and others') and successfully. Please remember that this guide has been given to you in good faith for free, and neither its accuracy nor legality can be relied upon.